

A New Artificial Intelligence Method for Prediction of Diabetes Type2

Karabpour SAMIRA¹, Jafarian AHMAD^{2,*}

¹ Department of Mathematics, Urmia Branch, Islamic Azad University, Urmia, Iran

² Department of Mathematics, Urmia Branch, Islamic Azad University, Urmia, Iran

Abstract

Diabetes is a chronic illness without a conclusive cure, and is the most common cause of amputations, blindness, and chronic kidney failure, and an important risk factor in heart problems. The only hope for these patients is through proper care. The main difficulty, regarding this dangerous and destructive illness, is not detecting it in time, and generally, a weakness in detection. Hence, implementation of a method that can help in the detection of this illness is an important step toward the prevention and control of this illness, especially in the early stages. In this article, using adaptive neural fuzzy inference system (ANFIS), we have attempted to predict this illness. The speed and the validity of the suggested algorithm is more than the other smart methods used. The method proposed in this article, with a 10% validity increase during training and a 5% validity increase during experimentation has a better performance than previous smart methods

Keywords: Diabetes, Adaptive neural fuzzy inference system, Fuzzy data, Fuzzy inference system, neural network

1. INTRODUCTION

Diabetes is a metabolic disorder in the body. In this illness, the body becomes incapable of producing insulin, or the body becomes resistant to insulin, and the insulin produced cannot perform its natural role. The main role of insulin is lowering blood sugar through various mechanisms. In diabetes, the speed and the ability to metabolize glucose completely is reduced, and the level of blood sugar increases. When this increase occurs for long periods of time in the body, micro vascular diabetic complications or damages to very small veins occur that can involve various organs in the body, such as the kidneys, the eyes, or the nervous system. Furthermore, diabetes has a direct correlation with risk of cardiovascular illnesses; hence, screening and early detection of this illness in individuals with high risk, can be effective in preventing these complications.

*Corresponding author

Email: Jafarian5594@yahoo.com

Many studies have been performed on the detection of diabetes. Amir Amiri et al. attempted to predict diabetes using a combination algorithm in 2014 [1]. In 2003, diabetes was diagnosed using neural networks and regression by K. Kayaer et al [2]. K. Polat et al. classified diabetes using the cascade learning system [3]. In 2011, Emirhan Gulcin yildirim et al. used data analysis methods on diabetes [4]. In 2012, diabetes prediction was improved using fuzzy neural networks [5]. In 2014, Hamid R. Marateb et al. proposed a combination smart system for detecting Albuminuria in type 2 diabetes patients without measuring albumin [6]. In 2014, Javad Akbari Torkestani proposed a method for adjusting blood sugar level based on automatic learning in type 2 diabetes [7]. In 2001, Dazzi, Davide et al. used a fuzzy neural network method for controlling blood sugar in diabetes patients [8]. In 2014, the effects of type 2 diabetes and high blood pressure with regards to thinning of brain membrane and disorder in vascular response among the elderly was analyzed by Ekaterina Tchistiakova et al. [9].

Other methods for the detection of this disease have been proposed, including methods based on artificial intelligence such as fuzzy algorithms for pattern recognition in characteristic extraction [10], SVM algorithm [11], genetic algorithm [12], RBF neural networks [13], MLP neural networks [14], and methods based on the Bayesian model [15]. In this article, a new method for predicting diabetes, using Adaptive Neural Fuzzy Inference System (ANFIS), is proposed. Development and evaluation of the model has been performed using real data sets. Gaussian membership functions, back propagation and hybrid algorithms have been used for network training. The desired model was created by preparing the required data regarding diabetes from existing information. According to the results, the model is able to predict diabetes successfully. The method proposed in this study, is considered a new approach in the diagnosis of this illness that is faster and more accurate than previous methods.

2. Materials and Methods

2.1. Introducing diabetes

Diabetes [16] is a metabolic disorder in the body. In this illness, the body becomes incapable of producing insulin, or the body becomes resistant to insulin, and the insulin produced cannot perform its natural role. The main role of insulin is lowering blood sugar through various mechanisms. Diabetes is divided into two main groups: dependent on insulin (type 1); and independent of insulin (type 2). Other types of diabetes also exist: the first

shows up during pregnancy and can be dangerous to the mother and the fetus, and the other follow identified damages, such as pancreas infection.

In type 1 diabetes [20], destruction of beta cells in the pancreas cause failure in insulin production. Diabetes caused by immunity usually occur in childhood and adolescence. In type 2 diabetes, which includes 90-95% of diabetic patients, the body becomes resistant to insulin functioning. In the beginning of their illness, these patients have a relative (not absolute) insulin deficiency. Meaning that patients' body produces insulin, and the insulin density may even be more than usual. But the receptor cells had become resistant to insulin, and in fact, don't allow insulin to enter the cells and perform its natural functions. These patients don't need outside insulin for survival. In most cases, the risk of this type of diabetes increases with age, being overweight, and lack of physical activity. It is more common in women with prior pregnancy– diabetes history, and individuals with high blood pressure or blood fat disorders. Type 2 has more genetic predisposition than type 1.

2.2. Adaptive Neural Fuzzy Inference System (ANFIS)

Adaptive Neural Fuzzy Inference System (ANFIS) [17] was introduced by Jung. According to Jung, ANFIS is a neural network [18] that is basically similar to the Takagi-Sugeno inferential model. ANFIS has turned into a powerful and attractive modelling technique. It combines the learning guidelines proposed in ANN and the lingual clarity of fuzzy logic [19] in the framework of adaptive networks. Fuzzy inference systems (FIS) are the most well-known applications of fuzzy logic. In FIS, membership functions should be generally adjusted manually through trial and error. FIS model acts like a white box, in other words the designers of the model can discover how the model has reached its objective. On the other hand, artificial neural networks (ANN) can learn, but act like a black box regarding the way they reached their objectives. Applying ANN techniques for proposing parameters of a fuzzy model enables us to learn from a specific set of training data, such as ANN. Furthermore, the solution given in the fuzzy model can be expressed as a set of If-Then rules.

2.2.1. ANFIS structure

ANFIS structure is shown in figure 1. Five layers have been used for the construction of this model. Each layer contains several nodes, which are expressed by that node's function. Adaptive nodes, shown as squares, display the set of parameters that are adjustable in the

respective node. On the other hand, fixed nodes, shown as circles, display parameters that are constant in the model.

The first layer contains adjustable nodes, whose membership functions are Gaussian or bell-shaped with a maximum of 1, and a minimum of 0. Membership function parameters, which are the same as parameters of fuzzy rules, are adjusted based on lingual expression of variables and fuzzy subspaces and based on hybrid methods.

$$O_{1,i} = \mu_{A_i}(x), \text{ for } i = 1, 2 \quad (1)$$

$$O_{1,i} = \mu_{B_{i-2}}(y), \text{ for } i = 3, 4 \quad (2)$$

Where x and y are the input node i , and A and B are the linguistic labels associated with this node, $\mu(x)$ and $\mu(y)$ are the membership functions. There are many types of MFs that can be used. However, a Gaussian shaped function is usually adapted.

Nodes of the second layer are considered to be constant. These nodes multiply two input signals and deliver the result to the network as their output. The input signals to these nodes are the rate of input adaptability with each of the membership functions and their output is the weight associated with each of the rules.

$$O_{2,i} = W_i = \mu_{A_i}(x) \cdot \mu_{B_{i-2}}(y), \text{ for } i = 1, 2 \quad (3)$$

Where $O_{2,i}$ is the output of the second layer.

The nodes of the third layer are also fixed and their function is to calculate the normalized weight of each of the rules.

$$O_{3,i} = \bar{W} = \frac{W_i}{W_1 + W_2}, \text{ for } i = 1, 2 \quad (4)$$

Where $O_{3,i}$ is the output of the third layer.

The nodes of the fourth layer multiply the normalized weight of each fuzzy rule by the latter part of that rule.

$$O_{4,i} = \bar{W}_i \cdot f_i, \text{ for } i = 1, 2 \quad (5)$$

Where f_1 and f_2 are If-Then fuzzy rules as described below:

- Rule 1: If x is the same as A_1 and y is the same as B_1 , then $f_1 = p_1x + q_1y + r_1$
- Rule 2: If x is the same as A_2 and y is the same as B_2 , then $f_2 = p_2x + q_2y + r_2$

Where p_i, q_i, r_i are specified parameters, which are known as the consequent parameters. If the mean of centers is used for defuzzification, the output is as follows:

$$f = \frac{w_1 f_1 + w_2 f_2}{w_1 + w_2} = \bar{w}_1 f_1 + \bar{w}_2 f_2 \text{ st } \bar{w}_1 = \frac{w_1}{w_1 + w_2}, \bar{w}_2 = \frac{w_2}{w_1 + w_2} \quad (6)$$

The fifth layer node collects all output signals from the fourth layer nodes and delivers them to the network.

$$O_{5,i} = \sum_i \bar{w}_i f_i = \frac{\sum_i w_i f_i}{w_i} = f_{out} = \text{overall output} \quad (7)$$

The hybrid algorithm (which combines the gradients reduction method and the least squares method for optimization of parameters) is applicable directly for the identification and estimation of network parameters. Latter rule parameters are linear network parameters that are estimated using the LSE method. Introductory parameters are adjusted using the gradient reduction method. In this article, the back Propagation and combination method are used.

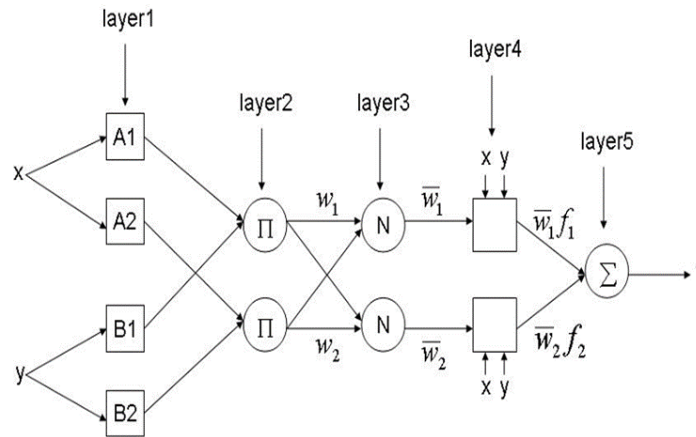

Fig. 1: Structure of Adaptive Neural Fuzzy System

3. Implementation and results

3.1 Data acquisition

Data is collected from Diabetic Patients Society of Urmia. Five factors for detection of diabetes are considered. These factors are displayed in table 1, and are used as input to the system. Structure of ANFIS has one output which shows whether the individual has diabetes or not.

Table 1: INTRODUCTION RELATED TO ANFIS VARIABLES FOR DETECTING DIABETES

	Hemoglobin (Alc)	
x₁= Hemoglobin Alc	<u>Hemoglobin Alc</u>	<u>Condition</u>
	Less than 5.7	Non-diabetic
	Between 5.7 and 6.4	Pre-diabetic
	Over 6.4	Diabetic
	Cholesterol	
x₂= Cholesterol	<u>Cholesterol</u>	<u>Condition</u>
	Less than 200 mg	Excellent
	Between 200 and 239	Borderline
	Over 240 mg	High (danger)
	Triglyceride	
x₃= Triglycerides	<u>Blood Triglyceride Level</u>	<u>Condition</u>
	Less than 150 mg	Excellent
	Between 150 and 199	Borderline
	Between 200 and 499	Dangerous
	Over 500 mg	Very Dangerous
	Body Mass Indicator	
x₄= BMI= $\frac{\text{weight (kg)}}{\text{height (m)}^2}$	<u>BMI</u>	<u>Condition</u>
	Less than 22	Thin
	Between 22 and 25	Normal
	Between 25 and 30	Overweight
	Between 30 and 35	Fat
	Over 35	Dangerous
	2 Hr. Blood Sugar	
x₅=Blood Glucose (2hrs. p. p.)	<u>2 Hr.BS</u>	<u>Condition</u>
	Less than 140	Non-diabetic
	Between 140 and 200	Pre-diabetic
	Over 200	Diabetic
	Fasting Blood Sugar	
Y=FBS	<u>FBS</u>	<u>Condition</u>
	Less than 100	Non-diabetic
	Between 100 and 125	Pre-diabetic
	Over 126	Diabetic

3.2. Results of ANFIS

In this section, the data as shown in Table 1, was used as input to adaptive neuro-fuzzy inference system (ANFIS), and the structure generated was based on fuzzy clustering as shown in Figure 2. The structure has 5 inputs, 1 output, and 10 clusters, given in Table 1. Each input contains 10 Gaussian membership functions, and the output contains 10 linear membership functions, and 10 rules. The system was trained using the Back Propagation (BP) and the hybrid methods. In this section the obtained diagrams will be discussed.

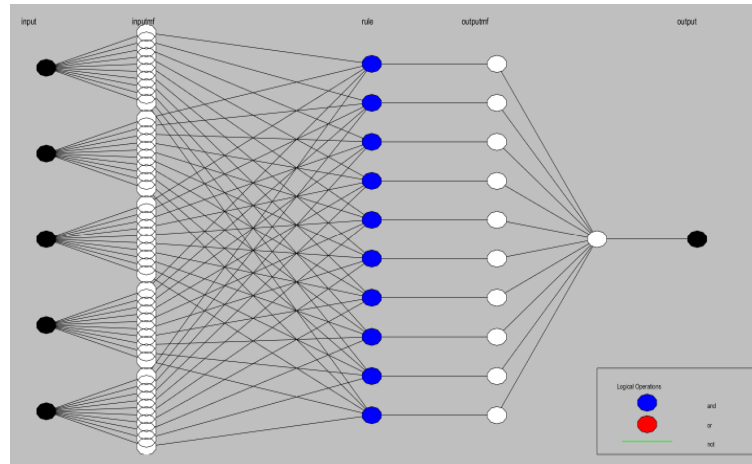

Fig. 2: ANFIS structure designed

3.2.1. Results obtained from the Back Propagation (BP) method

Figures 3 and 4 show the structure of the initial fuzzy inference system, which was based on fuzzy clustering structure. In figures 3 and 4 (a) the difference between ANFIS output and actual output during the training stage and test stage. As you can see, there is little difference between output data and the goal data. Figure 3 (b) shows RMSE error fluctuations during training ANFIS, and figure 4 (b) shows RMSE error fluctuations during ANFIS test. In figures 3 and 4 (c) histograms of the errors are displayed, where the value of the error is shown on the horizontal axis, and the plentitude is shown on the vertical axis.

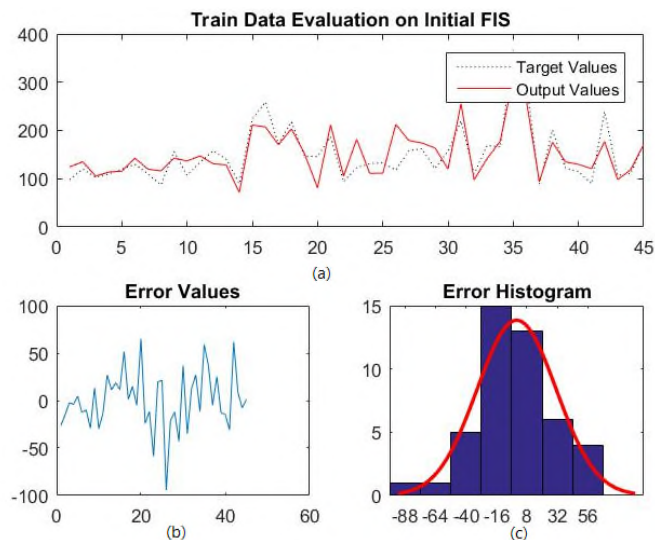

Fig.3: Difference between ANFIS output and actual outputs during ANFIS training stage

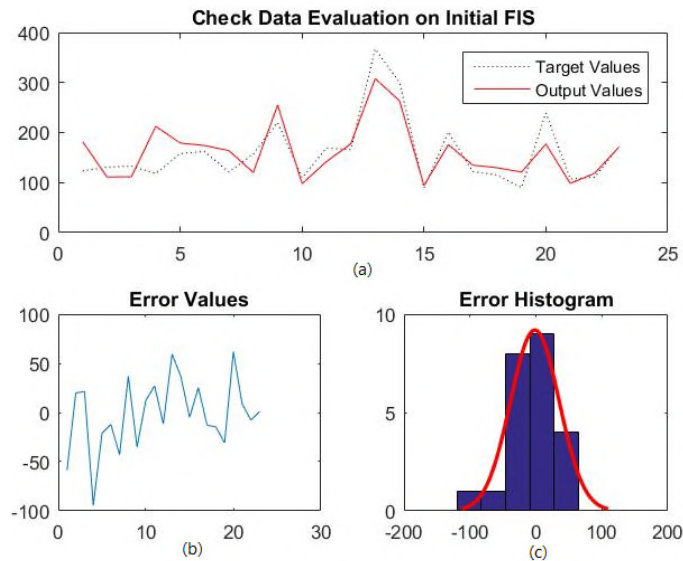

Fig.4: Difference between ANFIS output and actual outputs during ANFIS check stage

Figures 5 and 6 show the structure of the initial fuzzy inference system, which was based on fuzzy clustering structure. In figures 5 and 6 (a) the difference between ANFIS output and actual output during the training stage and test stage are shown. As you can see, there is little difference between output data and the goal data. Figure 5 (b) shows RMSE error fluctuations during training ANFIS, and figure 6 (b) shows RMSE error fluctuations during ANFIS test. In figures 5 and 6 (c) histograms of the errors are displayed, where the value of the error is shown on the horizontal axis, and the plentitude is shown on the vertical axis.

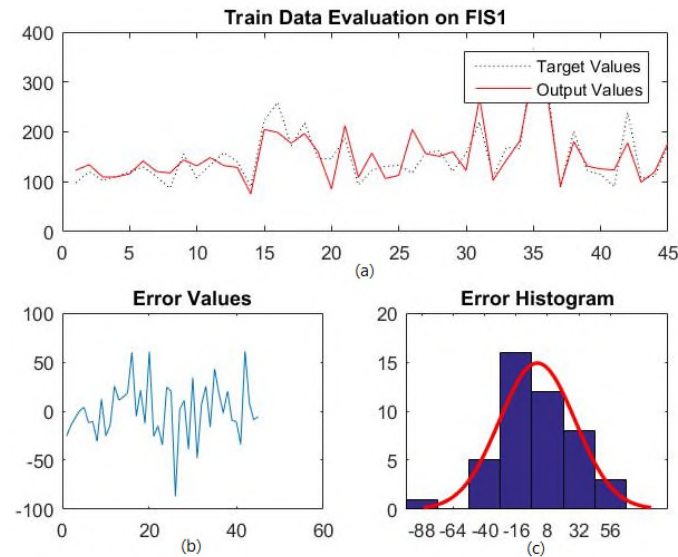

Fig. 5: Difference between ANFIS output and actual outputs during Fis1 training stage

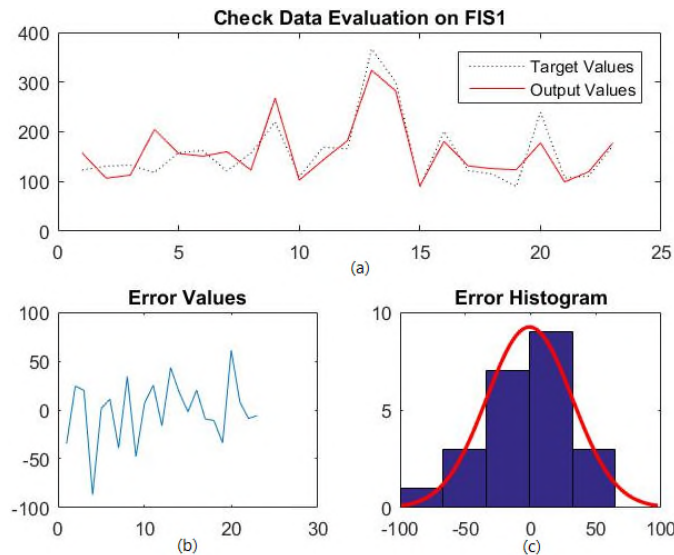

Fig. 6: Difference between ANFIS output and actual outputs during FIS1 check stage

Figures 7 and 8 show the structure of the initial fuzzy inference system, which was based on fuzzy clustering structure. In figures 7 and 8 (a) the difference between ANFIS output and actual output during the training stage and test stage are shown. As you can see, there is little difference between output data and the goal data. Figure 7 (b) shows RMSE error fluctuations during training ANFIS, and figure 8(b) shows RMSE error fluctuations during ANFIS test. In figures 7 and 8 (c) histograms of the errors are displayed, where the value of the error is shown on the horizontal axis, and the plentitude is shown on the vertical axis.

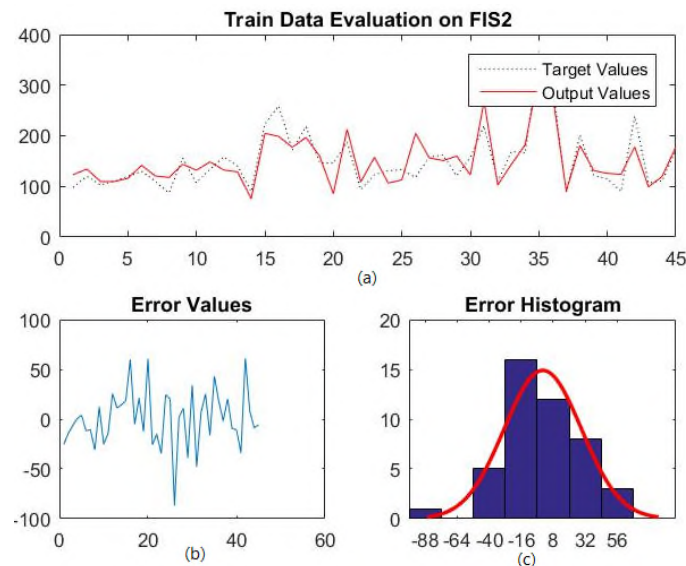

Fig. 7: Difference between ANFIS output and actual outputs during FIS2 training stage

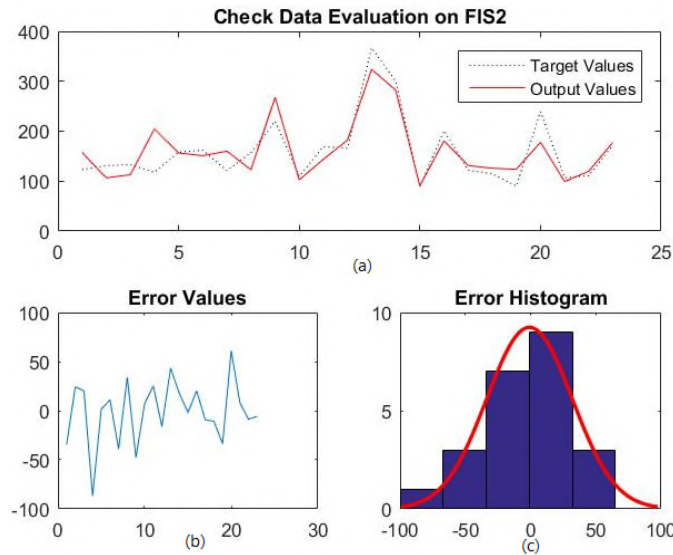

Fig. 8: Difference between ANFIS output and actual outputs during FIS2 check stage

3.2.2. Results obtained from the hybrid method

Figures 9 and 10 show the structure of the initial fuzzy inference system, which was based on fuzzy clustering structure. In figures 9 and 10 (a) the difference between ANFIS output and actual output during the training stage and test stage are shown. As you can see, difference between output data and the goal data is less than the BP method. Figure 9 (b) shows RMSE error fluctuations during training ANFIS, and figure 10 (b) shows RMSE error fluctuations during ANFIS test. In figures 9 and 10 (c) histograms of the errors are displayed, where the value of the error is shown on the horizontal axis, and the plentitude is shown on the vertical axis.

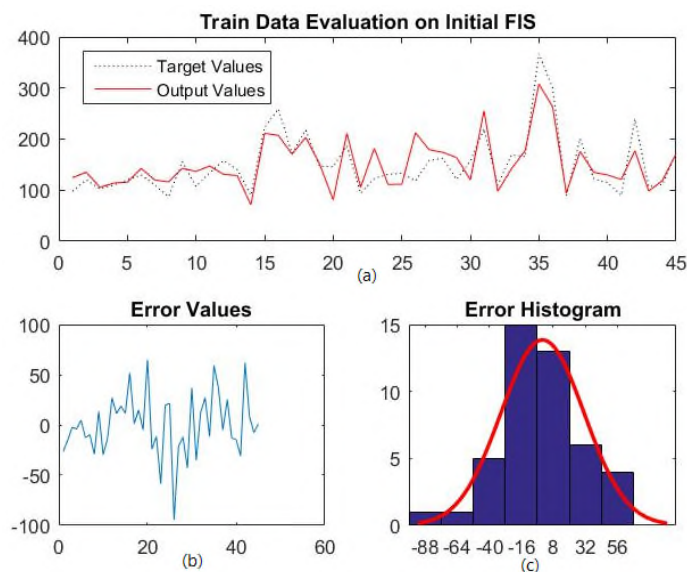

Fig. 9: Difference between ANFIS output and actual outputs during ANFIS training stage

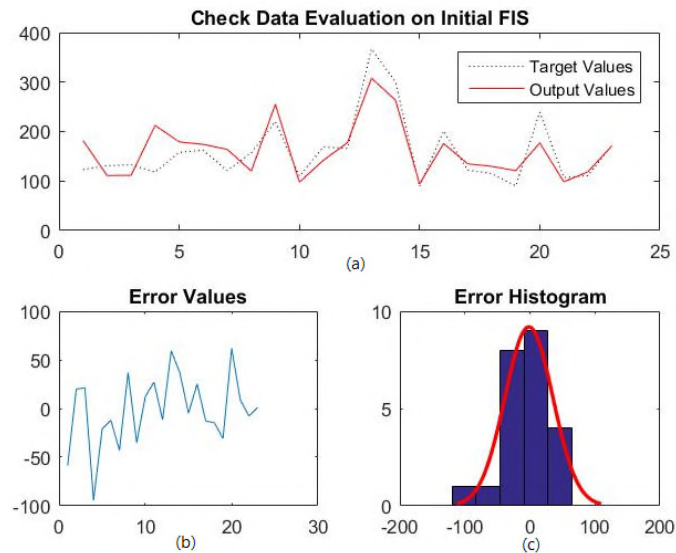

Fig. 10: Difference between ANFIS output and actual outputs during ANFIS check stage

Figures 11 and 12 show the structure of the initial fuzzy inference system, which was based on fuzzy clustering structure. In figures 11 and 12 (a) the difference between ANFIS output and actual output during the training stage and test stage are shown. As you can see, difference between output data and the goal data is less than the BP method. Figure 11 (b) shows RMSE error fluctuations during training ANFIS, and figure 12 (b) shows RMSE error fluctuations during ANFIS test. In figures 11 and 12 (c) histograms of the errors are displayed, where the value of the error is shown on the horizontal axis, and the plentitude is shown on the vertical axis.

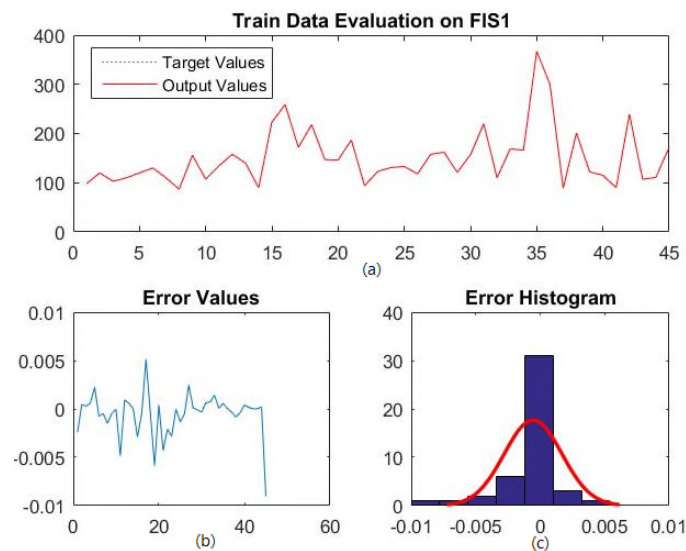

Fig. 11: Difference between ANFIS output and actual outputs during Fis1 training stage

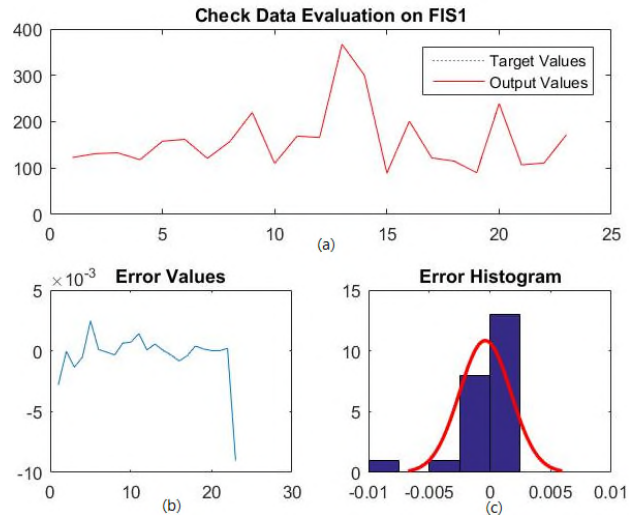

Fig. 12: Difference between ANFIS output and actual outputs during FIS1 check stage

Figures 13 and 14 show the structure of the initial fuzzy inference system, which was based on fuzzy clustering structure. In figures 13 and 14 (a) the difference between ANFIS output and actual output during the training stage and test stage are shown. As you can see, difference between output data and the goal data is less than the BP method. Figure 31 (b) shows RMSE error fluctuations during training ANFIS, and figure 14 (b) shows RMSE error fluctuations during ANFIS test. In figures 13 and 14 (c) histograms of the errors are displayed, where the value of the error is shown on the horizontal axis, and the plentitude is shown on the vertical axis.



Fig. 13: Difference between ANFIS output and actual outputs during FIS2 training stage

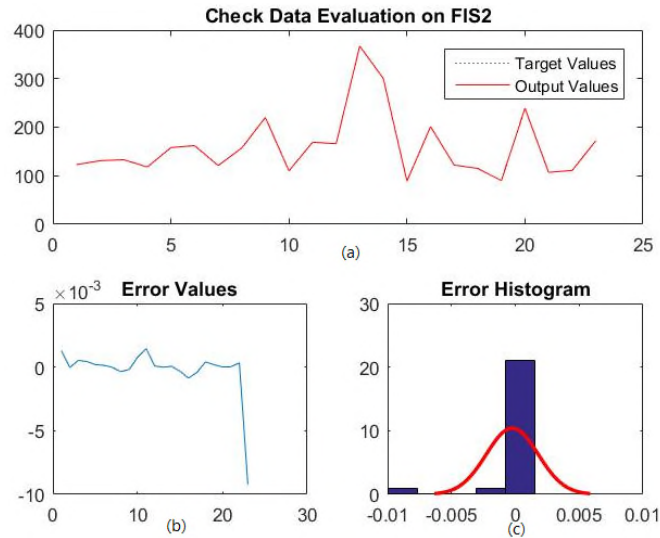

Fig. 14: Difference between ANFIS output and actual outputs during FIS2 check stage

3.2.3. Evaluation of the Back Propagation (BP) and the combined methods

The more the histogram of the plentitude of errors for each method of modelling resembles normal distribution, the more desirable the method. Considering the histograms of the errors arising from the adaptive neuro-fuzzy inference system and the combined method, it is seen that the results from this method are better. And, based on training and observing the difference between ANFIS output and actual output during training and ANFIS testing (which are quite negligible) and overlapping of the diagrams, it can be concluded that using trained adaptive neuro-fuzzy inference system along with the combined method based on fuzzy clustering gives better results. We can diagnose this illness more accurately using this method.

4. CONCLUSION

Diabetes is a chronic disease with many complications that is considered a fatal threat. Self-management in diabetes is a process in which the knowledge, skill, and abilities required to take managerial actions are facilitated. This process includes determination of needs, goals, and analyzing experiences of diabetic patients. The only hope for these patients is through proper care. By early detection of diabetes, its complications can be prevented.

The application of ANFIS is reducing input data dimensions, and extracting characteristics at the input section of ANFIS network. The structure of the ANFIS presented is based on fuzzy clustering, and for training the descending gradient algorithm and combined

algorithm were used. One of the most important advantages of using the presented system versus using common fuzzy methods is the significant reduction of fuzzy rules, which has a great effect on the amount of memory and time required for the implementation of the desired structure. Furthermore, it enables interpretation of the fuzzy system due to having the least possible number of rules. And, the performance of the presented ANFIS network is maintained to a large extent, because of the noticeable reduction in the number of rules. The number of rules and parameters for fuzzy systems with numerous inputs is severely high, that even prevents the implementation and management of these rules, which causes slow functioning and reduced coherence speed during training stage of the fuzzy system.

Results show that adaptive neuro-fuzzy inference system trained based on the combined algorithm gives more accurate results and less error, compared to descending gradient algorithm.

References

- [1] Mallat, S. (1999). A wavelet tour of signal processing. Academic press.
- [2] Pylarinos, D., Siderakis, K., Pyrgioti, E., Thalassinakis, E. and Vitellas, I. (2011). Automating the classification of field leakage current waveforms. Engineering. Technology & Applied Science Research, Vol. 1, No. 1, pp.8-12.
- [3] Amiri, A. and Rafe, V. (2014). Hybrid Algorithm for Detecting Diabetes. International Research Journal of Applied and Basic Sciences, vol. 8, no. 12, pp. 2347-2353.
- [4] Kayaer, K., Yıldırım, T. (2003). Medical diagnosis on Pima Indian diabetes using general regression neural networks. In Proceedings of the international conference on artificial neural networks and neural information processing (ICANN/ICONIP), pp. 181-184.
- [5] Polat, K., Güneş, S., Arslan, A. (2008). A cascade learning system for classification of diabetes disease: Generalized discriminant analysis and least square support vector machine. Expert Systems with Applications, vol. 34, no. 1, pp.482-487.
- [6] Yıldırım, E.G., Karahoca, A., Uçar, T. (2011). Dosage planning for diabetes patients using data mining methods. Procedia Computer Science, vol. 3, pp.1374-1380.
- [7] Thirugnanam, M., Kumar, P., Srivatsan, S.V., Nerlesh, C.R. (2012). Improving the prediction rate of diabetes diagnosis using fuzzy, neural network, case based (FNC) approach. Procedia Engineering, vol. 38, pp.1709-1718.
- [8] Marateb, H. R., Mansourian, M., Faghihimani, E., Amini, M., Farina, D. (2014). A hybrid intelligent system for diagnosing micro albuminuria in type 2 diabetes patients without having to measure urinary albumin. Computers in Biology and Medicine. Vol. 45, pp. 34-42.

- [9] Torkestani, J.A., Pisheh, E.G. (2014). A learning automata-based blood glucose regulation mechanism in type 2 diabetes. *Control Engineering Practice*, vol. 26, pp.151-159.
- [10] Dazzi, D., Taddei, F., Gavarini, A., Uggeri, E., Negro, R., Pezzarossa, A. (2001). The control of blood glucose in the critical diabetic patient: a neuro-fuzzy method. *Journal of Diabetes and its Complications*, vol. 15, no. 2, pp. 80-87.
- [11] Tchistiakova, E., Anderson, N.D., Greenwood, C.E., MacIntosh, B.J. (2014). Combined effects of type 2 diabetes and hypertension associated with cortical thinning and impaired cerebrovascular reactivity relative to hypertension alone in older adults. *NeuroImage: Clinical*, vol. 5, pp.36-41.
- [12] Larijani, B., Zahedi, F., Aghakhani, SH. (2003). Epidemiology of Diabetes Mellitus in Iran. *Shiraz E-Medical Journal*, Vol. 4, No. 4.
- [13] Kuncheva, L.I., Steimann, F. (1999). Fuzzy diagnosis. *Artificial intelligence in medicine*, vol.16, no. 2, pp.121-128.
- [14] Santhanam, T., Padmavathi, M.S. (2015). Application of K-Means and Genetic Algorithms for Dimension Reduction by Integrating SVM for Diabetes Diagnosis. *Procedia Computer Science*, vol. 47, pp.76-83.
- [15] Jaafar, S.F.B., Ali, D.M. (2005). September. Diabetes mellitus forecast using artificial neural network (ANN). In *Sensors and the International Conference on new Techniques in Pharmaceutical and Biomedical Research, 2005 Asian Conference on*, pp. 135-139.
- [16] Jiang, Y., Zhou, Z.H. (2004). Editing training data for kNN classifiers with neural network ensemble. In *Advances in Neural Networks–ISNN 2004*, Springer Berlin Heidelberg, pp. 356-361.
- [17] Su, J., Zhang, H. (2006). Full Bayesian network classifiers. In *Proceedings of the 23rd international conference on Machine learning*, pp. 897-904.
- [18] Temurtas, H., Yumusak, N., Temurtas, F. (2009). A comparative study on diabetes disease diagnosis using neural networks. *Expert Systems with applications*, vol. 36, no. 4, pp.8610-8615.
- [19] Jang, J.S.R. (1993). ANFIS: adaptive-network-based fuzzy inference system. *Systems, Man and Cybernetics, IEEE Transactions on*, vol. 23, no. 3, pp.665-685.
- [20] Zini, G., d’Onofrio, G. (2003). Neural network in hematopoietic malignancies. *Clin Chim Acta*, vol.333, no. 2, pp. 195-201.
- [21] Aliev, R., Pedrycz, W., Fazlollahi, B., Huseynov, O.H., Alizadeh, A.V., Guirimov, B.G. (2012). Fuzzy logic-based generalized decision theory with imperfect information. *Information Sciences*, vol. 189, pp.18-42.

- [22] Acharjee, S., Ghosh, B., Al-Dhubiab, B.E., Nair, A.B. (2013). Understanding type 1 diabetes: etiology and models. Canadian journal of diabetes, vol. 37, no. 4, pp.269-276.